



**Puretec**<sup>®</sup>  
PERFECTING WATER



# User Guide

Puretec Radfire UV Water Sanitizer

**RI-37K | RI-60K INDUSTRIAL UV SYSTEM**

For correct operation & installation it is essential to observe these instructions.

Congratulations on purchasing this ultraviolet disinfection system. By purchasing a Puretec UV Disinfection system you are receiving not only a high quality product but also peace of mind. Protecting your water supply with a UV system gives you reassurance that the water being treated by this UV system is microbiologically safe without the addition of any potentially harmful chemicals. This process is simple, effective and carries the lowest O&M costs of all the disinfection processes. Simple maintenance, continuous disinfection and ultimately safe water, PURETEC makes it that easy.

## TABLE OF CONTENTS

Product Matrix.....	Page 4
Safety Considerations.....	Page 4
Before You Begin .....	Page 4
Water Quality Parameters.....	Page 5
Assembly.....	Page 6
System Sizing .....	Page 7
Location .....	Page 7
Installation .....	Page 8
System Disinfection .....	Page 12
Cleaning (quartz sleeve & UV sensor).....	Page 13
Operation (5.0 & 6.0 Control Panel).....	Page 14
Operation (5.0 & 6.0 3-Position Switch) .....	Page 14
Operation (5.0 & 6.0 Power-up) .....	Page 15
Operation (5.0 & 6.0 UV Intensity).....	Page 15
Operation (5.0 & 6.0 Lamp Countdown) .....	Page 16
Operation (5.0 & 6.0 Lamp Countdown Reset) .....	Page 16
Operation (5.0 & 6.0 Failure Modes).....	Page 16
Expansion Options .....	Page 17
Warranty Registration .....	Page 17
Limited Warranty Statement.....	Page 18

## Product Matrix:

PRODUCT MATRIX				
SYSTEM	"Normal" Disinfection 30 mJ/cm <sup>2</sup> @ 95% UVT	Hot Water Disinfection 30 mJ/cm <sup>2</sup> @ 75% UVT	LOW UVT Disinfection 30 mJ/cm <sup>2</sup> @ 50% UVT	TOC Disinfection 150 mJ/cm <sup>2</sup> @ 95% UVT
Single lamp "35" series	LR5-355	LR5-355-HW	LR5-355	LR5-355-TOC
	LR6-355	LR6-355-HW	LR6-355-50	LR6-355-TOC
Single lamp "55" series	LR5-555	LR5-555-HW	LR5-555	LR5-555-TOC
	LR6-555	LR6-555-HW	LR6-555-50	LR6-555-TOC
Single lamp "85" series	LR5-855	LR5-855-HW	LR5-855	LR5-855-TOC
	LR6-855	LR6-855-HW	LR6-855-50	LR6-855-TOC
Double lamp "110" series	LR5-1105	LR5-1105-HW	LR5-1105	LR5-1105-TOC
	LR6-1105	LR6-1105-HW	LR6-1105-50	LR6-1105-TOC
Double lamp "140" series	LR5-1405	LR5-1405-HW	LR5-1405	LR5-1405-TOC
	LR6-1405	LR6-1405-HW	LR6-1405-50	LR6-1405-TOC
Double lamp "175" series	LR5-1755	LR5-1755-HW	LR5-1755	LR5-1755-TOC
	LR6-1755	LR6-1755-HW	LR6-1755-50	LR6-1755-TOC
European CEE 7/7, 3-wire for all 230V. - "2" suffix (i.e. LR5-352) British Standard, BS 1363, 3-wire for all 230V. - "3" suffix (i.e. LR6-553-HW) Australian AS/NZ 3112, 3-wire for all 230V. - "4" suffix (i.e. LR6-1754-50) North American, NEMA 6-15, 3 prong - "5" suffix				

## Safety Consideration:

Although your UV system has been manufactured to the highest safety standards, extreme care must be followed when operating and/or maintaining your system.

1. Whenever you are servicing this equipment, always disconnect the power cord.
2. As the energy given off by the UV lamp can be harmful to your eyes and skin, NEVER look directly at an illuminated UV lamp without adequate eye protection and always protect your skin from direct exposure to the UV light.
3. To ensure the system provides adequate disinfection, ALWAYS replace any component (lamp and sleeve) with a genuine manufacturer's replacement part.
4. Do not operate the unit if it has any damaged or missing components.
5. To avoid possible electrical shock, use only with a properly grounded electrical outlet.
6. Never perform any maintenance to the system unless you are comfortable in doing so. Contact the manufacturer for service instructions if required.
7. Do not use this system for any purpose other than what it was intended for. Misuse of this system could potentially cause harm to the user.
8. Your system is intended to be installed indoors and away from leaking plumbing. DO NOT plug the unit in if the system or any of the components are wet.



9. The disinfection system should be directly installed into a ground fault circuit interrupter (GFCI). Please note that as the Radfire product line is available in 230 volt only, special High-current GFCI's (GFI's) are required. These special GFCI's can easily be obtained through an electrical supply house, or are readily available from a local spa/hot tub supply store as they are commonly used in these applications.
10. We recommend that a licensed plumber or certified technician perform the installation

## Before You Begin:

Before you begin, you'll need the following:

### Tools

- Pipe cutter, hacksaw or other specialized tools required to cut into your existing plumbing (e.g. if you have PEX piping)
- Soldering tools (torch, flux, emery cloth and solder)
- Wrench (for tightening fittings)

### Other Materials

- Inlet/outlet connections
- Teflon™ tape

## Water Quality Parameters:

UV disinfection is extremely effective against microorganisms but only if the UV light can pass through the water it needs to treat. This means that the quality of your water is very important in order to ensure complete disinfection.

It is imperative that you have your water tested for at the least the parameters listed below. If the water exceeds the listed parameters PURETEC strongly recommends that appropriate pretreatment equipment be installed (pretreatment will depend on parameters targeted):

<b>Hardness:</b>	<7 GPG (120 mg/L) – if hardness level is 7 GPG (grains per gallon) or slightly below the quartz sleeve must be cleaned periodically in order to ensure efficient UV penetration; if above the water must be softened
<b>Iron (Fe):</b>	<0.3 ppm (0.3 mg/L)
<b>Manganese (Mn):</b>	<0.05 ppm (0.05 mg/L)
<b>Turbidity:</b>	< 1 NTU
<b>Tannins (organics):</b>	<0.1 ppm (0.1 mg/L)
<b>UVT (transmittance):</b>	>85% (Please contact PURETEC if water has a UVT that is less than 80% for pre-treatment recommendations)

You can have your water tested at a private analytical laboratory or by your local dealer. It is always recommended to install pre-filtration of at least 5 microns prior to a PURETEC UV disinfection system.

## Assembly:

**Step 1:** Unpack the system and ensure all the components are included with the system. Your system is shipped with the following components:

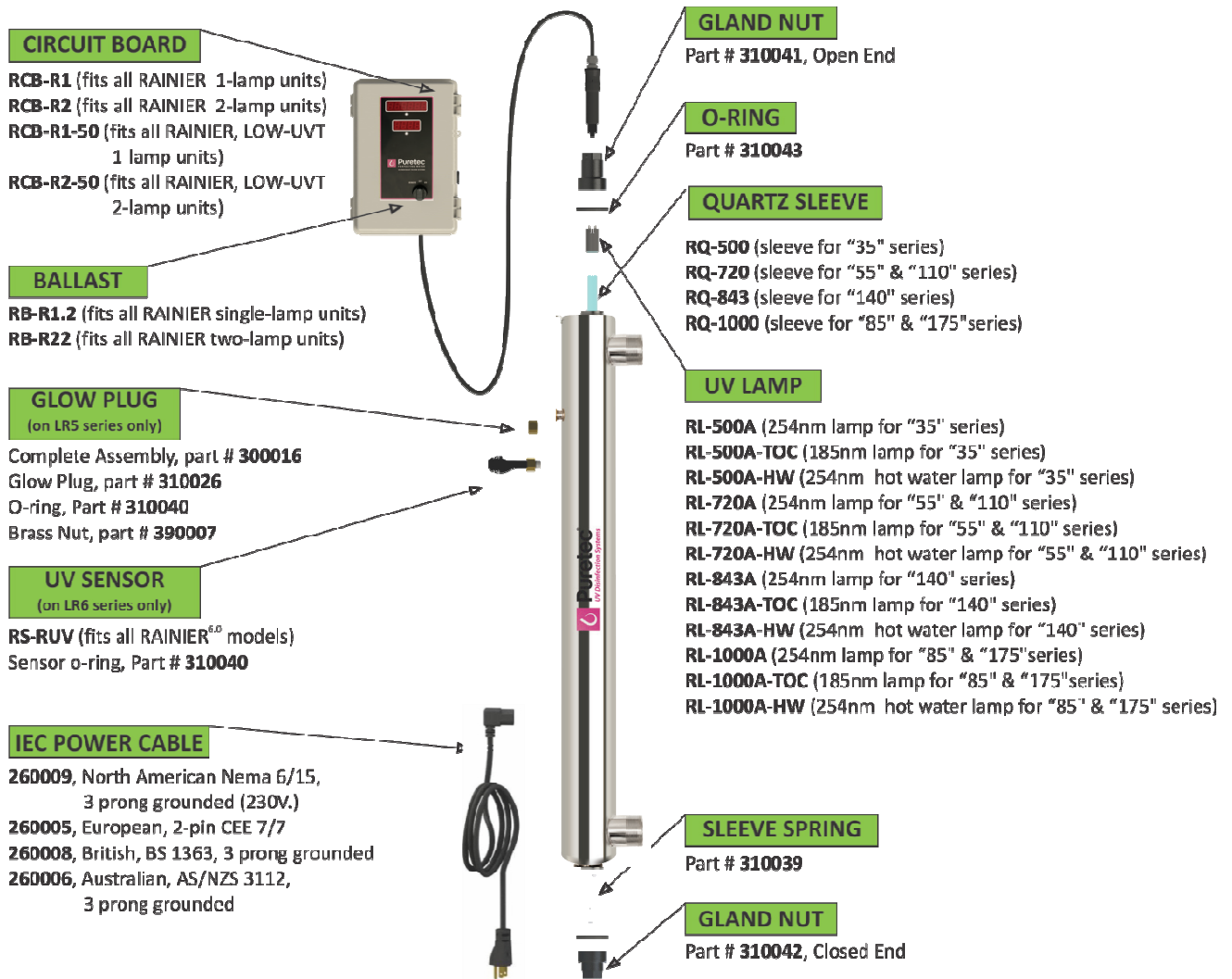


Figure 1. Radfire system components

## System Sizing:

All PURETEC UV systems are rated for a specific flow rate under specific water quality parameters. The equipment has been designed to ensure that the appropriate dose will be delivered provided all outlined parameters are met. **PLEASE NOTE** that unless a flow restrictor is part of the installation, the system may pass more water through the system than what the system is rated at. If this happens, the system may be delivering a UV dose level that is below what may be expected. As a result, the maximum flow as specified in the equipment specifications should be strictly adhered to (a lower flow is not a concern as the dose will increase due to a longer contact time).

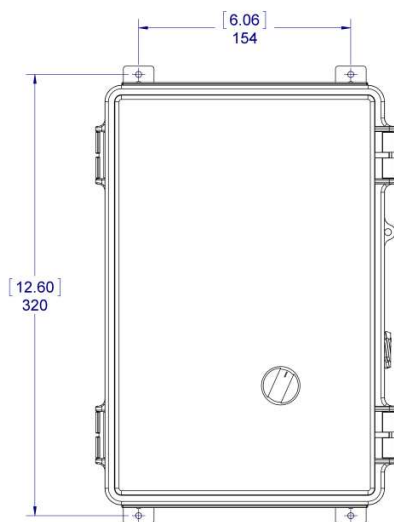
It is important to know the maximum flow rate that your water system delivers. If you do not have this information you can simply fill a 1 gallon bucket with water from a faucet and time how long it takes to fill up. This will be the maximum flow rate for that particular water system. Choose a **Radfire** system that is suitable.

**PLEASE NOTE:** It is always better to oversize your UV system than to undersize. There will come a time where the water demand will reach the system's maximum capacity.

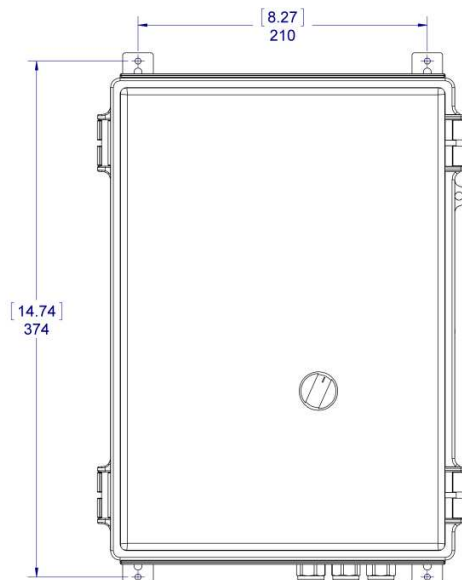
## Location:

**Step 1:** Find a suitable location to mount the UV reactor and the accompanying control panel. In choosing your location ensure that the panel is located within 5 feet of a ground fault circuit interrupter (GFCI) and that there is easy access to the main cold water line prior to any branch lines and before the hot water heater. The panel can be up to 8 feet away from the reactor or a maximum of 5 meters if custom lamp cables are ordered (for an additional cost). If you have any other water treatment equipment, such as a softener or water filter, ensure that the UV is the last piece of treatment equipment. **PLEASE NOTE:** All PURETEC UV disinfection systems are intended for indoor use only as they should not be exposed to the elements.

**Step 2:** There are two different **Radfire** control panels, depending on which system is purchased. The three single lamp systems ("35", "55" and "85" series) use a control panel that is 32.0 x 20.0 x 15.0 cm (12.6 x 7.9 x 6.1") in size (see Figure 2), while the three two-lamp systems use a control panel that is 37.4 x 30.0 x 21.0 cm (14.7 x 11.8 x 8.3") in size (see Figure 3).



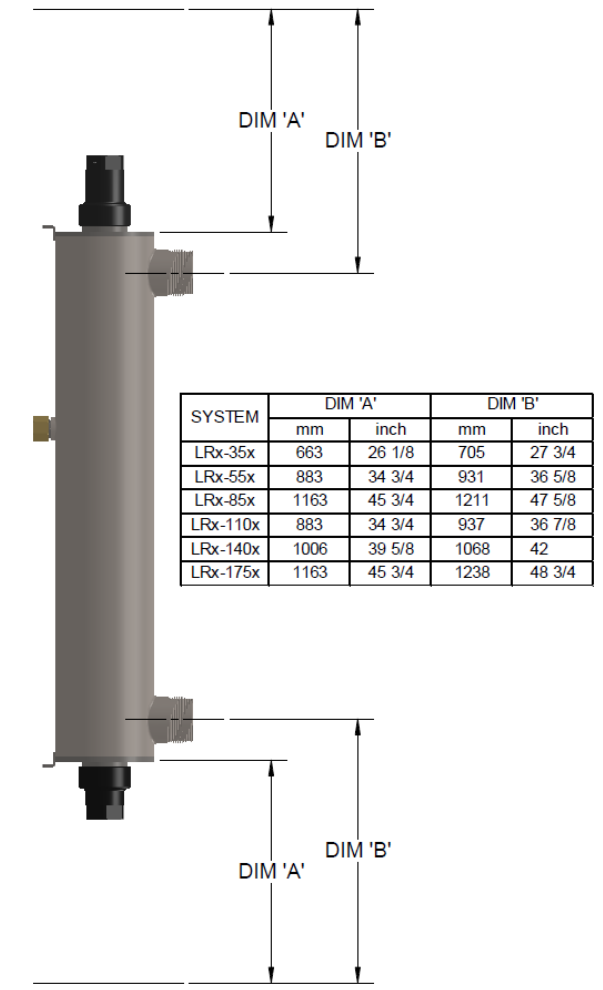
**Figure 2. One-Lamp Systems**



**Figure 3. Two-Lamp Systems**

**Step 3:** Your UV system includes mounting hardware for the UV reactor and the control panel. If the supplied fasteners are not compatible with the structure in which you are mounting the device, please ensure you use the correct fasteners.

**Step 4:** To facilitate lamp removal, ensure there is enough space at one end to safely remove the UV lamp and/or quartz sleeve (a space equal to the length of the unit will suffice) (see Figure 4).



**Figure 4. Lamp Removal Spacing**

### Installation:

**Step 1:** The UV disinfection system should always be the last piece of treatment before the water branches off to any hot or cold water lines.

**Step 2:** PURETEC strongly recommends that a 5 micron filter be installed **before** the UV system for a final polishing step before the water is disinfected.

**Step 3:** The reactor can be installed either horizontally or vertically using the clamps provided, however vertical installation is the preferred method with the inlet at the bottom (lamp connection at the top) as it allows any air that may be in the lines to be easily purged from the UV system.

**Step 4:** If you do not know the flow rate of the water supply in the application, it is recommended that you use a flow restrictor so that the rated flow of your particular **Radfire** system is not exceeded and the UV dose is not compromised. The flow restrictor should be installed on the outlet port of the reactor.

**Step 5:** It is strongly recommended to have a licensed plumber connect the UV reactor to the water supply and may be a requirement depending on where you are located. If you are attempting this yourself, ensure you have all the necessary tools and fittings to accomplish this task.

**Step 6:** Although there are many methods of installation, this manual will provide a recommended procedure using copper plumbing and standard soldering methods. PURETEC recommends the use of unions, a by-pass assembly and shut-off valves as this will allow you to isolate and remove the UV reactor if necessary (this is a recommended method only however it allows for the maximum convenience but it requires extra components and more time for installation).

**Step 7:** Before you cut into the cold water line, measure and cut all piping as per the recommended layout. Once all the components are ready, start by installing the female adapters onto the ports of the reactor. To ensure a proper seal, the use of Teflon™ tape is recommended on all threaded connections.

**Step 8:** Next solder all the assembly together, including ball valves and unions and finally connected the by-pass assembly to the cold water feed line (water in and water out).

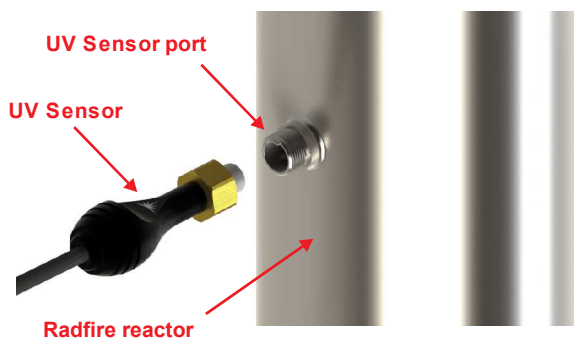
**Step 9:** You can now gently remove the quartz sleeve from its packaging being VERY careful not to touch the length with your hands. The use of cotton gloves (not included) is recommended for this procedure as oils from our hands can leave residue on the sleeve and lamp which can ultimately block the UV light from getting to the water. In the package, you will find two lubricated o-rings.

**Step 10:** Carefully slide the sleeve into the reactor until you can feel it hit the opposite end of the reactor. Maneuver the sleeve gently until it slides through the opposite end of the reactor. With a ¼" of the sleeve sticking out each end of the reactor slide one o-ring onto each end. Ensure that each o-ring is butted up against the reactor (see Figure 5). Assemble the bottom gland nut (the black nut without the through hole) onto the threaded end of the reactor and tighten. The gland nuts have a positive stop to avoid over-tightening, hand tighten ONLY. Next, assemble the top gland nut (the black nut with the through hole) onto the threaded end of the reactor and tighten. Slide the provided stainless steel compression spring inside the quartz sleeve. This spring simply sits in the bottom of the quartz sleeve and works with the lamp and lamp connector to create the proper lamp alignment. **PLEASE NOTE:** DO NOT install a UV lamp inside the quartz sleeve without the sleeve spring in place.

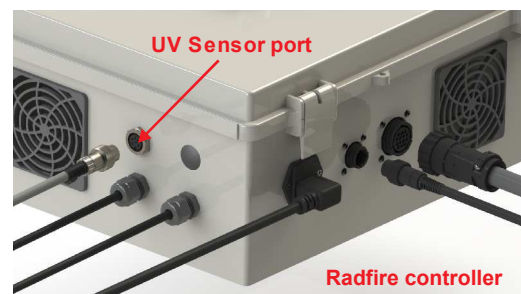


**Figure 5. Quartz Sleeve Installation**

**Step 11: (Applies only if you have a UV sensor - Radfire).** The UV sensor for three system is packaged in a separate plastic bag. Carefully remove the sensor from its packaging and insert the sensor into the UV sensor port (remove the protective cap on the UV reactor first). The sensor can only go in one way. Ensure that the flat portion of the UV sensor matches up with the half metal lip on the sensor port (flat portion should face the lamp connection end) (see Figure 6). Ensure that the sensor is fully seated in the sensor port and then tighten (turning clockwise) the sensor nut. **PLEASE NOTE: DO NOT** over tighten the nut as this could damage the Teflon sensor body. Plug the male connector into the sensor port located on the right side of the control panel, (see Figure 7), (make sure the control panel is not plugged in as the sensor **MUST** be attached before power is applied to the panel).



**Figure 6. UV Sensor Installation**



**Figure 7. Sensor Connection**

**Step 12:** The reactor is now ready for water flow. When all plumbing connections have been completed you should check for any possible leaks. Slowly turn on the water supply and check for leaks. Make sure the by-pass valves are functioning properly and that the water is flowing through the reactor. The most common leak is from the o-rings not making a proper seal on the reactor. If this is the case turn the water off, drain the reactor, remove each o-ring, dry them and reapply silicon grease. Replace each o-ring ensuring they are properly sealed against the reactor, re-tighten the gland nuts and check again for leaks.

**Step 13:** The control panel can now be mounted on the wall. It should always be above or beside the reactor to ensure that no moisture can deposit on any of the connections. For safety purposes the control panel should be connected to a ground fault circuit interrupter (GFCI) (also known as a ground fault interrupter (GFI)). The control panel can be mounted up to 8 feet away from the reactor unless custom cables have been purchased.

**Step 14:** You can now remove the UV lamp from its packaging being careful not to touch the lamp quartz with your hands. Again, the use of cotton gloves is recommended to avoid deposited oils on the lamp glass. Always hold the lamp by the ceramic ends. Carefully insert the UV lamp into the reactor sliding it inside the quartz sleeve located inside the reactor (do not drop the lamp into the reactor). With the lamp outside of the reactor, affix the UV lamp to the lamp connector as shown in Figure 8.

**Step 15:** Before the lamp is completely inserted into the sleeve, affix the lam to the lamp connector as shown in Figure 8. Affix the LUMI-Loc™ connector into the gland nut by inserting the connector into the nut and turning the connector approximately ¼ turn to lock the connector to the gland nut (see Figure 9).

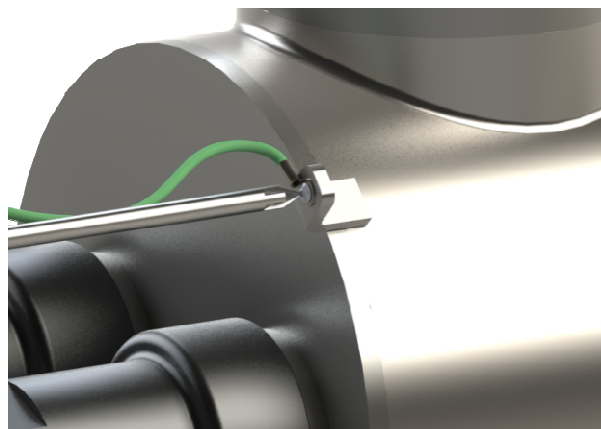


**Figure 8. UV Lamp Connection**



**Figure 9. LUMI-Loc™ Connector**

**Step 16:** Affix the captive ground screw to the ground lug on the UV reactor to ensure proper grounding continuity (see Figure 10).



**Figure 10. Ground Screw Connection**

**Step 17:** Your system is now ready to be plugged into the appropriate GFCI protected outlet. Plug the unit in and refer to the “System Disinfection” section before any water is allowed to flow through the system.

### **System Disinfection:**

Now that the system is installed you will need to disinfect the lines throughout the entire home or facility. To accomplish this, please follow these simple steps:

**Step 1:** Before performing this task, check to make sure that there are no “dead ends” in the lines within the water system you are treating as these can harbor bacteria. Also ensure that the UV system is powered-up and ready for operation before you start this disinfection process.

**Step 2:** Remove the cartridge from the filter sump and fill with 1-2 cups of household bleach (most household bleaches are 5.25% chlorine). Replace filter sump and slowly turn on the water supply.

**Step 3:** Go to each location in the home or facility (including outdoor taps) and run some water until chlorine can be detected (by smell). Ensure all faucets, dishwasher, shower heads, washing machine, toilets, showers, refrigerators, etc. are all checked. Once the chlorine is detected at each location close all faucets and let the chlorine sit in the lines for a minimum of 30 minutes.

**Step 4:** After 30 minutes, reinstall the filter cartridge into the filter sump and then flush the chlorine solution by opening all faucets and let them run until chlorine can no longer be detected (by smell). Your home/facility has now been completely disinfected and your **Radfire** UV system is ready to inactivate any microorganisms that enter the water system.

**PLEASE NOTE:** This procedure must be performed following any time the UV is shut down for service, without power, or is inoperative for some reason in order to avoid possible contamination of the water lines.

### **Cleaning the Quartz Sleeve:**

Depending on the water quality, the quartz sleeve may require periodic cleaning. At a minimum, the quartz sleeve should be cleaned on an annual basis. The following steps outline a basic cleaning procedure.

**Step 1:** If the system has an inlet shut-off valve, shut this valve off to prevent water flow through the system. If there is no inlet shut-off valve, turn off main water inlet valve (and turn off water pump if you have one).

**Step 2:** Disconnect power cord of UV system from electrical outlet.

**Step 3:** Release water pressure by opening a downstream faucet and close the outlet shut-off valve if the installation includes one (if there is no outlet shut-off valve, be prepared for water leakage from the system as the head pressure in the system will cause water to flow back through the outlet plumbing and through the reactor).

**Step 4:** Remove the captive ground screw from the ground lug on the UV reactor.

**Step 5:** Remove the lamp connector from the reactor (gland nut) by pushing the LUMI-loc connector in and turning it ¼ turn counter-clockwise (gently pull on the lamp cable to ensure the connector is seated properly).



**Step 6:** Pull lamp out of reactor still attached to connector.

**Step 7:** Remove the gland nut from each end of the reactor exposing the ends of the quartz sleeve.

**Step 8:** While holding on to both ends of the sleeve carefully remove the o-ring from the end opposite from the lamp connection and then pull the quartz sleeve out of the reactor (ensure that no water enters the inside of the quartz sleeve); remove second o-ring

**Step 9:** Using a soft, lint-free cloth or towel wipe the sleeve down using CLR<sup>®</sup> or LIME-A-WAY<sup>®</sup> (or other commercial scale cleaner) to remove any scaling or iron deposits that may be on the outside of the quartz sleeve. Be careful not to get any moisture or liquids on the inside of the sleeve.

**Step 10:** Wipe the sleeve with separate dry cloth.

**Step 11:** Once the sleeve is cleaned slide it back into the reactor following the steps outlined on page 9 of the manual.

**Step 12:** Replace both o-rings.

### **Cleaning the UV Sensor (if applicable):**

Depending on the water quality, the UV sensor may require periodic cleaning. At a minimum, the UV sensor should be cleaning on an annual basis. The following steps outline a basic cleaning procedure.

**Step 1:** If the system has an inlet shut-off valve, shut this valve off to prevent water flow through the system. If there is no inlet shut-off valve, turn off main water inlet valve (and turn of water pump if you have one).

**Step 2:** Disconnect power cord of UV system from electrical outlet.

**Step 3:** Release water pressure by opening a downstream faucet and close the outlet shut-off valve if the installation includes one (if there is no outlet shut-off valve, be prepared for water leakage from the system as the head pressure in the system will cause water to flow back through the outlet plumbing and through the reactor).

**Step 4:** Place something under the reactor to catch any water that may come out of the reactor during the removal of the UV sensor.

**Step 5:** Unscrew (counterclockwise) sensor nut from the reactor and pull the sensor slowly out of the sensor port.

**Step 6:** Holding the sensor in your hand wipe the flat portion (sensor face) of the sensor with isopropyl alcohol using a clean lint-free cloth.

**Step 7:** Replace sensor as per instructions on pages 10 of this manual

### **Operation:**

The PURETEC **RADFIRE** system comes with a feature laden control system that incorporates both the lamp driver (ballast) and control features in one modular panel. **CAUTION:** Prior to performing any maintenance on your UV system, you must always disconnect the power (DO NOT SIMPLY USE THE SWITCH ON THE FRONT OF THE CONTROLLER).

## RADFIRE Control Panel



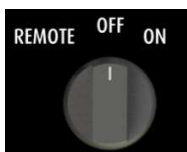
The control panel features a power factor corrected and constant current lamp driver. Simplistic in operation, the panel features an LED display for remaining lamp life, total running hours, audible and visual lamp failure, remote on and solenoid ready. When the UV lamp(s) is/are on, the second LED box will read "ON". When the UV lamp(s) is/are not on, the LED box will read "OFF" and an audible alarm will sound. **Please Note:** If the LED reads "OFF" and the alarm is sounding then the water from the system should NOT be consumed. If any water does pass through the UV system during this period, please follow the disinfection procedure as outlined in this manual before the water is consumed. It should also be noted that on the **RADFIRE** system even though this system does have a visual and audible warning built into the controls, the LED reading "ON" does not necessarily indicate that the water coming from this system is in fact potable (safe to drink). This system does not measure the level of disinfection; it simply measures the "ON-OFF" status of the lamp. For a constant reassurance of safe water quality you should consider the **RADFIRE** as it comes equipped with a UV sensor (you can also add the optional RS -RUV sensor on all **RADFIRE**'s systems) . Please have your water checked for microbiological contaminants on a regular basis.

## RADFIRE 3-Position Switch



The control panel features a 3-position user-selectable switch. This switch is NOT a power switch and it should be noted that once the control panel is plugged into an electrical outlet, the unit is powered and considered "ON". The switch functions as follows:

**"ON"** position – Power is supplied to the lamp(s) and the controller will read "ON" on the lower LED display on units without a UV sensor installed and will read the intensity (or UV output) on units with a UV sensor installed. Please note that when first starting the lamp(s), the system will cycle through a declining numerical sequence while the lamp(s) reaches full power.



**"OFF"** position – Power is NOT supplied to the lamp(s) and the lamp(s) will be off. The controller will read "OFF" on the lower LED display.



**"REMOTE"** position – In this position, the control of the unit is placed in a remote location (i.e. a computer) via an attached remote cable. Through this cable, the operator must supply a 24 volt power source that will allow these "dry contacts" to operate. The screens and the "ON" and "OFF" functions will now all be operated remotely. While the UV controller is in the remote position, **EXTREME CAUTION** must be exercised around the UV reactor while servicing the UV lamps as they may be turned on or off remotely without the operators knowledge or control. As a result, it is not recommended to service the lamp(s) while the controller is in the "REMOTE" mode and the system should be physically disconnected from the power source, or the controller manually switched to the "OFF" position while servicing the lamp(s).

### RADFIRE Power-up Sequence



Upon start up, the **RADFIRE** controls will indicate when the system is ready for treatment by the indicated countdown on the bottom LED screen. In this time, the UV Output of the lamp is increasing and the “Ready For Flow” logic is “NO”. After 180 seconds, if the UV output level is adequate for disinfection, the “Ready for Flow” logic is “YES” and the system will operate as intended.

### UV Output



If your system is equipped with a UV sensor, **RADFIRE** will display the UV output in either “% UV Intensity” or “mW/cm<sup>2</sup>”. The default output is “% UV Intensity” and to toggle between these two outputs, simply press the button located directly beneath the bottom LED screen. The UV Output LED screen will indicate the level of UV intensity that is being detected within the reactor by the sensor. This will always be visible on the front of the control panel. Things that can affect the UV Output are poor water quality, scaling of the quartz sleeve and/or sensor, lamp failure, expired lamp life and sensor failure.



When the UV output drops to 60%, the system will display a “LOW UV” warning light in yellow and the system will emit an intermittent audible chirp to signal this “LOW UV” condition. When the UV output drops to 50% the system will display a “LOW UV” warning light in red and the system will emit an constant audible alarm to signal this critical “LOW UV” condition. Additionally, at this point, the controller also provides a signal to de-activate the flow of water if implemented in the system. When the system registers a low UV condition, the only way to silence the alarms is to correct the reason for this low UV condition. This may be the result of an aged lamp, or a fouled sleeve and/or sensor, or perhaps a change in water quality. Please refer to other sections in this manual for direction on remedying these situations.

### Major Alarm Set Points:

System No. of Lamps	SYSTEM	Intensity (mW/cm <sup>2</sup> )	UVT(%)
1	Regular, TOC, HW	17	50
1	Low UVT	13	50
2	Regular, TOC, HW	15	50
2	Low UVT	10	50

### Minor Alarm Set Points

System No. of Lamps	SYSTEM	Intensity (mW/cm <sup>2</sup> )	UVT(%)
1	Regular, TOC, HW	20.3	58
1	Low UVT	15.6	60
2	Regular, TOC, HW	18	60
2	Low UVT	12	60

### RADFIRE Lamp Countdown Sequence

The **RADFIRE** control panel displays a countdown feature that displays the number of hours remaining until a lamp change is required. At 512 hours until lamp change the numerical lamp change value will begin to flash indicating that lamp expiration is near. At “zero hours remaining”, the system register an audible alarm. If you wish to silence this audible alarm condition, simply press and hold down the button located directly beneath the top LED screen for a period of three seconds. **PLEASE NOTE:** During the condition of lamp expiration, the water may be unsafe for consumption and should not be consumed without another form of disinfection.

### RADFIRE Lamp Countdown Reset Sequence

After changing the lamp on the **RADFIRE** systems, the control panel must be reset in order for the system to begin its countdown function on the newly installed lamp. To reset, simply press and hold down the button located directly beneath the top LED screen for a period of fifteen seconds. Release the button and the lamp countdown feature has now been reset.

### RADFIRE Failure Modes

The **RADFIRE** control panel continuously monitors your UV system and if there is a problem with the system the panel will provide both a visual and audible signal indicating the specific fault that may be adversely affecting the operation of your system. The fault conditions are listed in a priority sequence as follows: :



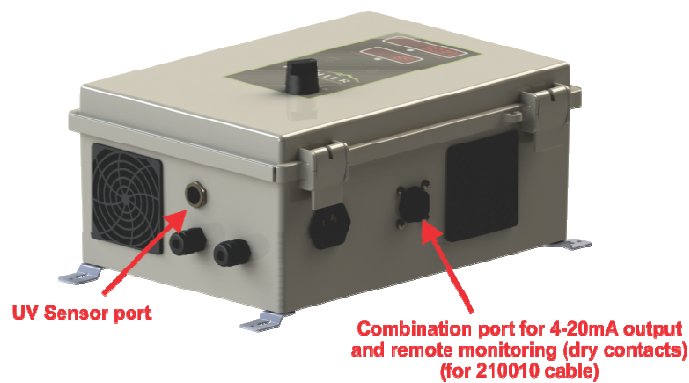
**LAMP FAILURE:** If at any time during the operation of the system, the UV lamp fails to be illuminated, the controller will return both an audible and visual signal indicating lamp failure. In addition, a constant audible buzzer will sound during lamp failure.



**UV SENSOR FAILURE:** Assuming the system has a UV Sensor installed, if at any time during the operation of the system, a UV sensor fails, the controller will return a “FAIL” indicator on the bottom LED screen and a constant audible buzzer will sound during sensor failure.

### RADFIRE Options

Although features such as remote monitoring and 4-20 mA output are built into the controller, their output requires optional cables as shown below. Each cable and mating connector are unique in regards to their size, so there is no chance of installing the wrong cable in the wrong connector. A single connector is used for both the 4-20mA output and remote monitoring.



The following optional cables are available for use on your **RADFIRE** systems. Contact your authorized distributor for purchasing information.



**Remote Cable (for both 4-20ma and remote monitoring options) Cable (Part # 210010):** Includes connector and 10m (33') of cable to provide both a 4-20 mA signal, and a dry contact signal to a remote location.

**Ethernet Module:** Allows for all controller functions to be connected to a computer via an Ethernet cable. This module is currently in development and is not available at this point-in-time. Please contact your Dealer for more details.

## Warranty Registration

It is imperative that you complete the warranty registration process. This not only registers your UV disinfection system for the provided manufacturer's warranty, but also allows the factory to provide you with any important product updates or technical bulletins concerning your product. The registration process is a simple process and can be done online at [www.puretecgroupp.com/warranty](http://www.puretecgroupp.com/warranty) or by filling out the attached warranty card. Please ensure that ALL information is filled in, including a valid e-mail address.

**PLEASE NOTE:** This information is for the sole purpose of technical support for your disinfection system and will not be used, or sold, to any other organization for any other purpose. Please refer to PURETEC's Privacy Policy statement at [www.puretecgroupp.com](http://www.puretecgroupp.com) for further information.

## Limited Warranty Statement:

Products manufactured by PURETEC are warranted to the original user only to be free of defects in material and workmanship for a period as specified below. This warranty only applies to the original purchaser and is not transferable.

### UV SYSTEMS

Ten (10) year Limited Warranty on the stainless steel reactors, from the date of original purchase, or installation (proper documentation required for verification).

### ELECTRONICS

Three (3) year Limited Warranty on the ballasts and controllers, from the date of original purchase, or installation (proper documentation required for verification).

### UV LAMPS, UV SENSORS & QUARTZ SLEEVES

One (1) year Limited Warranty on all PURETEC ultraviolet lamps, UV sensors and quartz sleeves from the date of original purchase, or installation (proper documentation required for verification).

PURETEC warrants that it will repair, replace or refund, at PURETEC's sole option, any ultraviolet system or component that is defective in materials or workmanship for the period as outlined above, subject to the "Limitations of Warranty" as outlined below. PURETEC's liability under this warranty shall be limited to repairing or replacing at PURETEC's option, without charge, F.O.B. PURETEC's factory or authorized service depot, any product that PURETEC manufactures. PURETEC will not be liable for any costs of removal, installation, transportation, or any other charges which may arise in connection with a warranty claim. Products which are sold but not manufactured by PURETEC are subject to the warranty provided by the manufacturer of said products and not by PURETEC's warranty. PURETEC will not be liable for damage or wear to products caused by abnormal operating conditions, accident, abuse, misuse, unauthorized alteration or repair, or if the product was not installed in accordance with PURETEC's printed installation and operating instructions.

### LIMITATIONS OF WARRANTY

This warranty does not apply to any of the following:

- Water Quality Parameters lie outside of the following ranges
  - Hardness > 120 mg/L (7 GPG)

- Iron > 0.3 mg/L (ppm)
  - Manganese > 0.05 mg/L (ppm)
  - Tannins > 0.1 mg/L (ppm)
  - Turbidity > 1 NTU
  - Transmittance (UVT) < 75%
- A product that has been incorrectly installed according to the technical installation manual.
  - A product that has been modified in any manner, unless approved by the manufacturer.
  - A product where the serial number has been altered defaced or removed.
  - Damage caused by the use of parts that are not compatible, suitable and/or authorized by PURETEC for use with the product (e.g. non-original lamps or sleeves).
  - Damage caused during shipment of the product.
  - Water damage is found inside ballast housing or controllers.
  - Product is installed outdoors in direct contact with the environment (rain).
  - Product is installed in freezing temperatures.
  - Product is used in conditions that exceed PURETEC's specifications.

#### **TO GET WARRANTY SERVICE**

To obtain service under this warranty, you must first contact PURETEC Customer Service at 1300 140 140 AU 0800 130 140 NZ to obtain a Warranty Return Authorization. You will then need to return the product through the PURETEC Dealer or Distributor where the product was originally purchased, together with proof of purchase and installation date, failure date, and supporting installation data. Unless otherwise provided, the Dealer or Distributor will contact PURETEC for instructions on returning the product. Any defective product to be returned to PURETEC must be sent freight prepaid; documentation supporting the warranty claim and/or a Return Material Authorization must be included if so instructed.

PURETEC WILL NOT BE LIABLE FOR ANY INCIDENTAL OR CONSEQUENTIAL DAMAGES, LOSSES, OR EXPENSES ARISING FROM INSTALLATION, USE, OR ANY OTHER CAUSES. THERE ARE NO EXPRESS OR IMPLIED WARRANTIES, INCLUDING MERCHANTABILITY OR FITNESS FOR A PARTICULAR PURPOSE, WHICH EXTEND BEYOND THOSE WARRANTIES DESCRIBED OR REFERRED TO ABOVE.

THIS LIMITED WARRANTY IS THE SOLE AND EXCLUSIVE WARRANTY MADE BY PURETEC WITH RESPECT TO THE PRODUCT, AND IS GIVEN IN LIEU OF ANY OTHER WARRANTY. TO THE EXTENT ALLOWED BY APPLICABLE LAW, ANY AND ALL EXPRESS OR IMPLIED WARRANTIES NOT SET FORTH HEREIN ARE WAIVED AND DISCLAIMED, INCLUDING ANY IMPLIED WARRANTY OF MERCHANTABILITY OR FITNESS FOR A PARTICULAR USE. PURETEC LIABILITY UNDER THIS LIMITED WARRANTY IS LIMITED SOLELY TO THOSE LIABILITIES SET FORTH ABOVE. IN THE EVENT THAT ANY PROVISION OF THIS LIMITED WARRANTY SHOULD BE OR BECOME INVALID OR UNENFORCEABLE UNDER APPLICABLE LAW, THE REMAINING TERMS AND CONDITIONS HEREOF SHALL REMAIN IN FULL FORCE AND EFFECT AND SUCH INVALID OR UNENFORCEABLE PROVISION SHALL BE CONSTRUED IN SUCH A MANNER AS TO BE VALID AND ENFORCEABLE.



**AUSTRALIA**

P 1300 140 140

E [sales@puretec.com.au](mailto:sales@puretec.com.au)

W [puretec.com.au](http://puretec.com.au)

**NEW ZEALAND**

P 0800 130 140

E [sales@puretec.co.nz](mailto:sales@puretec.co.nz)

W [puretec.co.nz](http://puretec.co.nz)